

L.L.Bean

Assembly Instructions

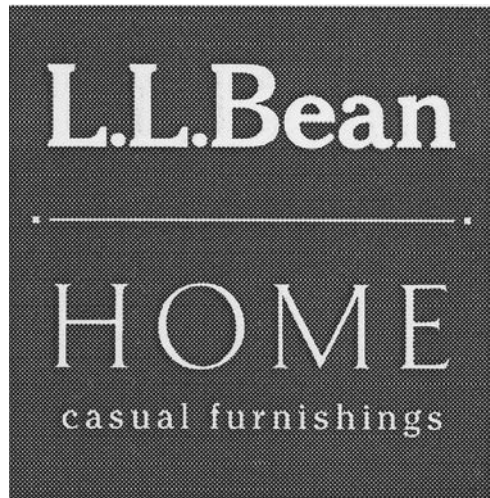

www.llbean.com

Product Support 1 800 341 4341

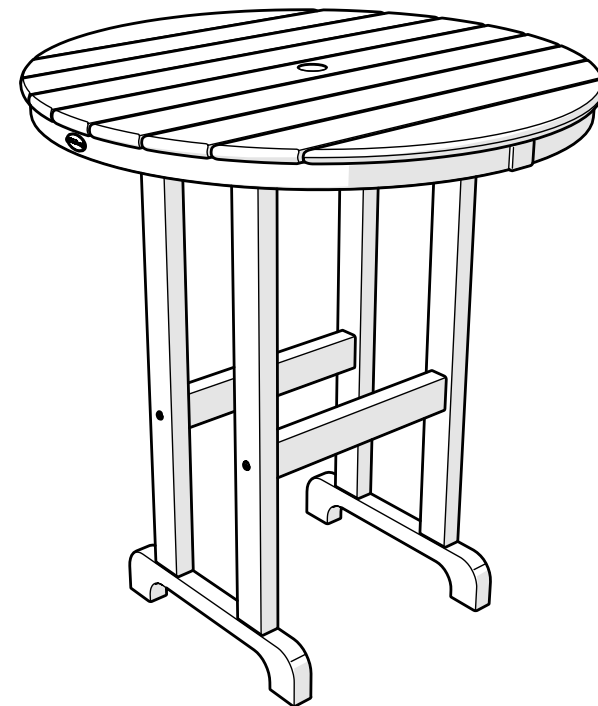

**All-Weather Counter
Height Table 36" Round**

Care

This material is made of HDPE plastic resin that has been purified and UV protected. It is generally cared for and cleaned with soap and warm water. For certain stains and additional cleaning power, a 1/3 bleach and 2/3 water solution can be used on the product without affecting the color. Also, a popular method of cleaning is a high-pressure power wash. (Not to exceed 1,500 psi, which is the equivalent of a car wash.) The surface characteristics of the product may require the use of a soft bristle brush to get into the creases.

The hardware used in the assembly and construction of our furniture is 18-8 stainless steel with an AlloChrome 3200+™ finish and a cosmetic coating, providing a high level of corrosive resistance.

A practical solution to signs of corrosion is to wash the product with soap and water, using a soft bristle brush to scrub the corroding areas of the hardware. Also, use appliance touch up paint in the appropriate color to protect the hardware. Appliance touch up paint can be purchased at local hardware stores.

Thank you for purchasing our All-Weather Counter Height Table 36" round.

Assembly of this product requires a 4mm Hex Key which is included.

We have found it helpful to have a second person

TOOLS

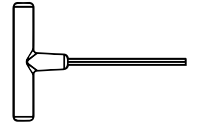

4mm T-handle hex key (included)

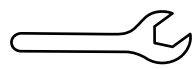

3/8" wrench (included)

PARTS

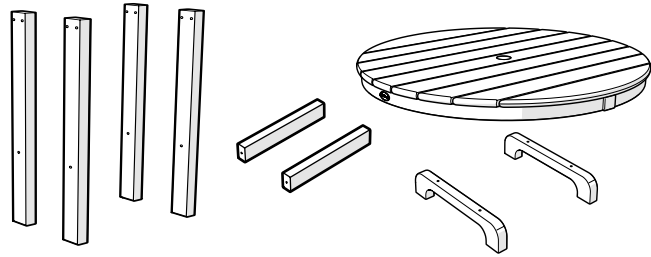

A x 4

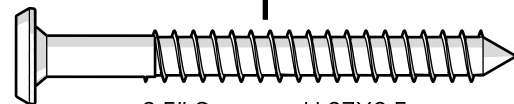

2.5" Screw — H.27X2.5

B x 4

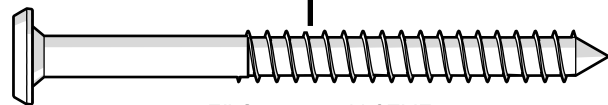

3" Screw — H.27X3

C x 8

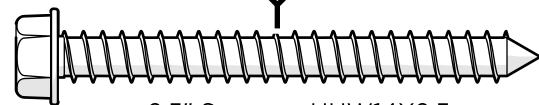

2.5" Screw — HHW14X2.5

