









# Item # 46636 Ivory Composite : Eucalyptus Wash Dining Table

## Assembly Instruction & Care:

Please assemble on soft a surface after removing contents as not to scratch or damage stone surface. Also, take caution with finger prints and dirt during assembly of Ivory table top. Wash with soft cloth and mild detergent like Dawn or Palmolive diluted with warm water. Scrub gently. Enjoy!



TABLE ASSEMBLY INSTRUCTIONS  
www.outdoorinteriors.com

Item	Description	Q'ty
A	 Bolt 8x80	02
B	 Bolt M8x50	12
C	 Flat Washer M8	12
D	 Washer	02
E	 Nut M8	02
F	 Allen Key	01
G	 Wrench	01
H	 Umbrella Plug	01

**STEP 1** • Assemble two table base legs with crossbar.  
• Attach (2) "A" Bolts, (2) "D" Washers, (2) "E" Nuts.  
**CAUTION: Insert "A" Bolts by hand and turn until they stop turning approx one-third to half way.**

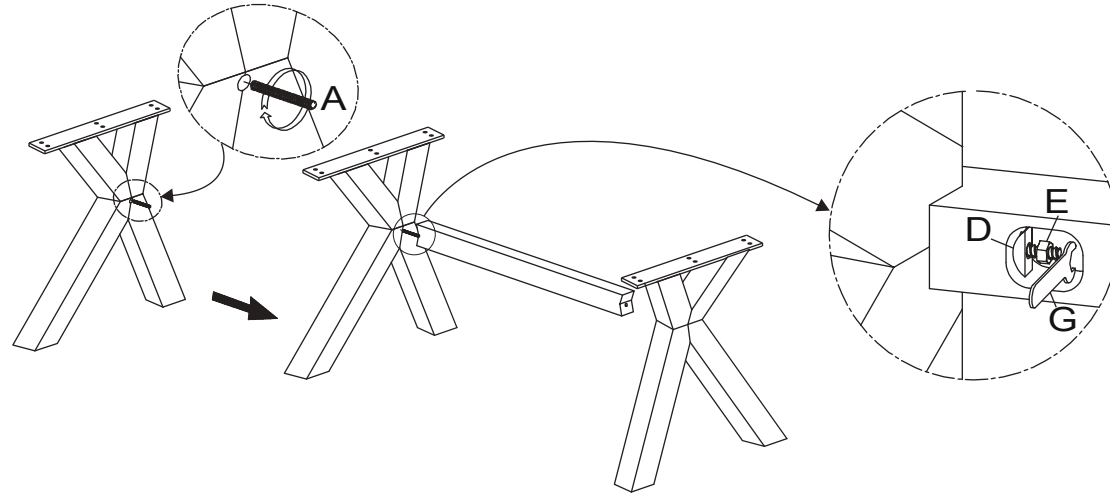

Table Top

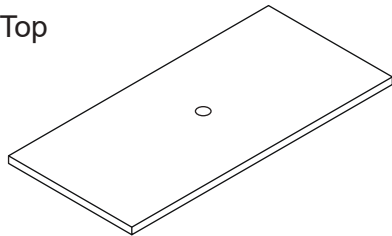
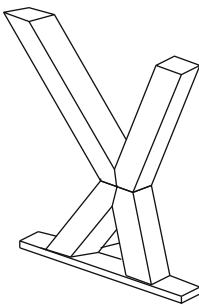
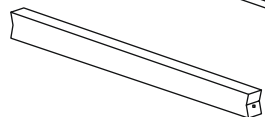

Table Base(2pcs)



Crossbar



**STEP 2** • Place table top on a soft surface upside down as shown.  
• Fasten (12) "B" Bolts and (12) "C" Flat washers to table top underside and frame.

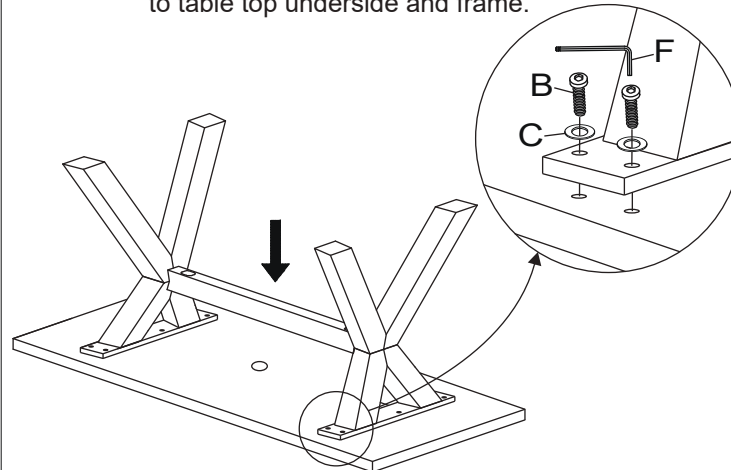

**STEP 3** • With 2 people carefully stand table upright.

