

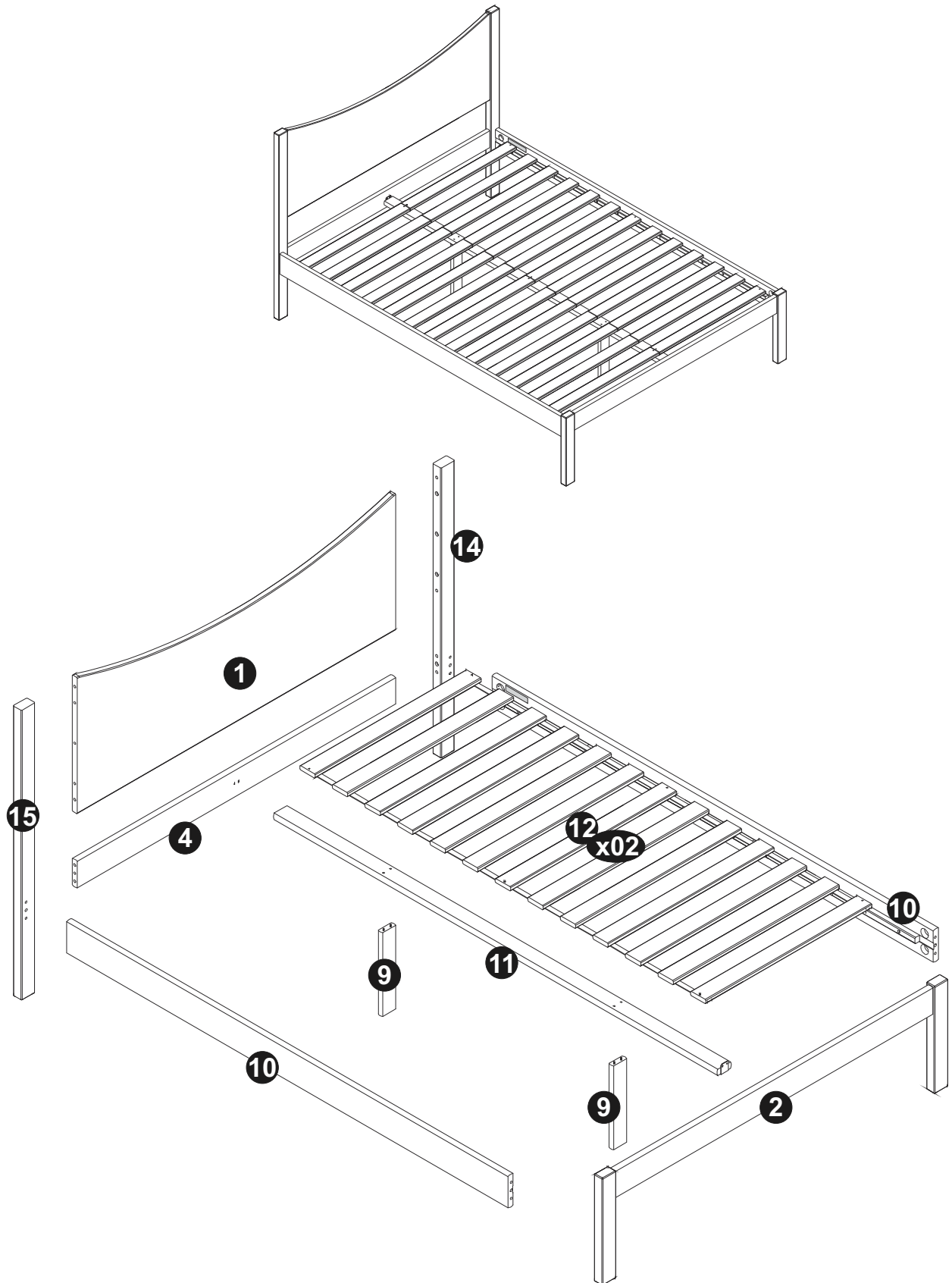









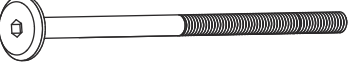

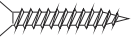
L.L.Bean

ASSEMBLY INSTRUCTIONS CURVED BED

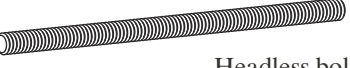

A	 Ø10x40mm	12
D	 1/4 x 80mm	04
E	 Half moon nut 1/4 x 4	04
F	 Ø3,5x16mm	08
G	 Ø4,0x35mm	12
H	 Ø7,0X60mm	04
I		01
J		02
K	 Headless bolt 1/4 x 70mm	04
L	 Small washer	12
M	 Nut 1/4	12
N	 Spanner	01
O	 Headless bolt 1/4 x 80mm	08

REPLACEMENT PARTS

Please do not contact the company purchased from as we can help you faster.
Order replacement parts and hardware at www.llbean.com

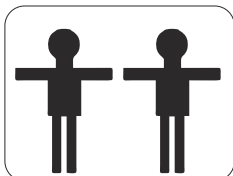

60 minutes

Tools Required









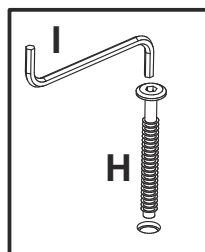
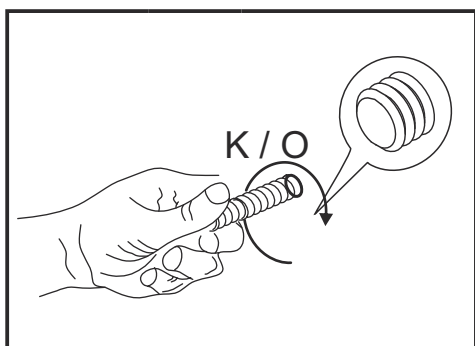
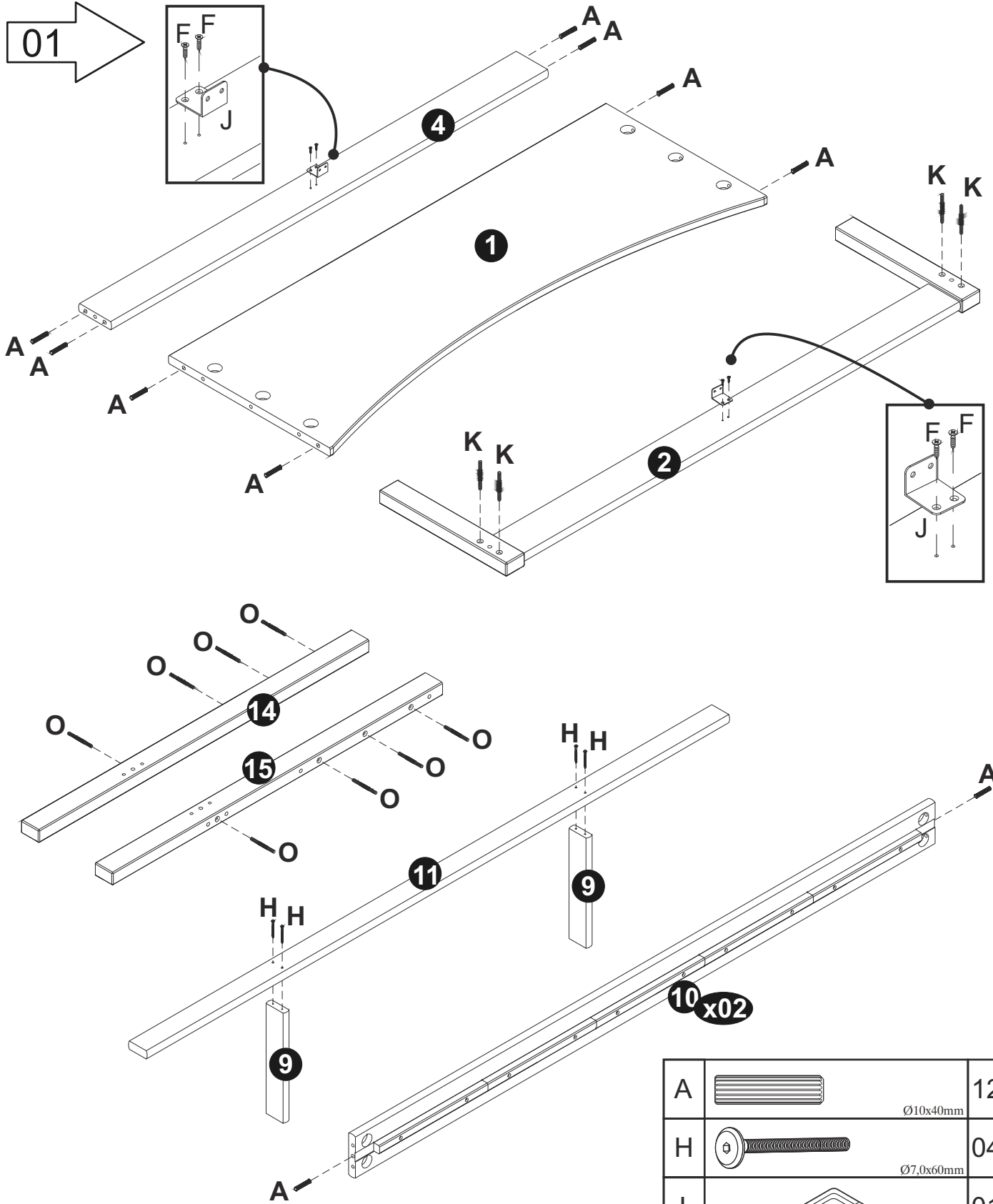

Phillips Tool



Hammer
* These tools are not supplied by the manufacturer

01



A		Ø10x40mm	12
H		Ø7,0x60mm	04
I			01
F		Ø3,5x16mm	04
J			02
K		Headless bolt 1/4 x 70mm	04
O		Headless bolt 1/4 x 80mm	08

02

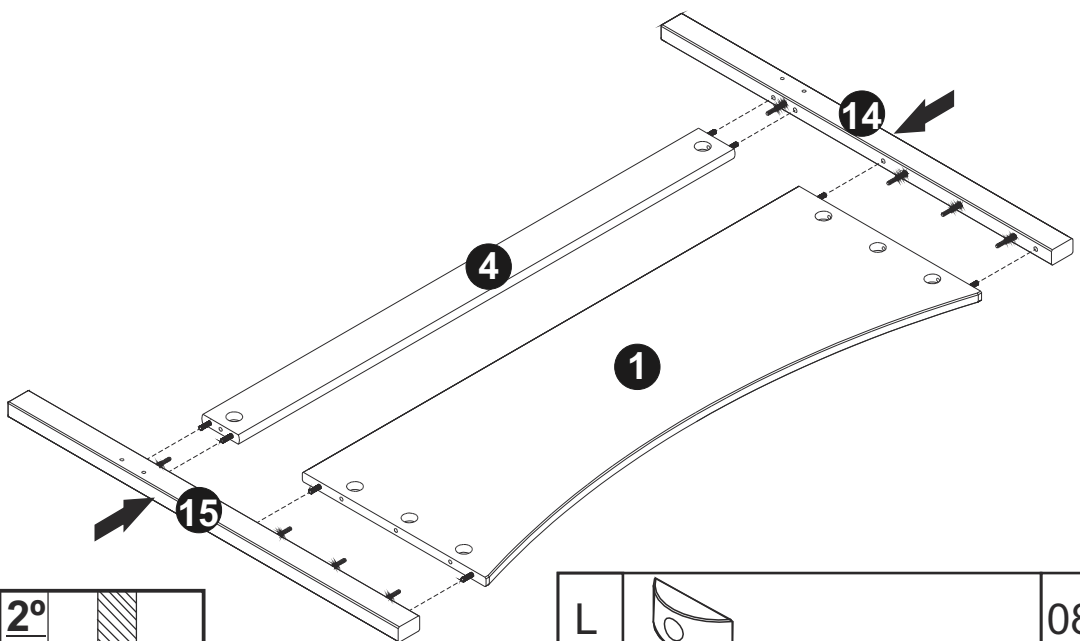

x08

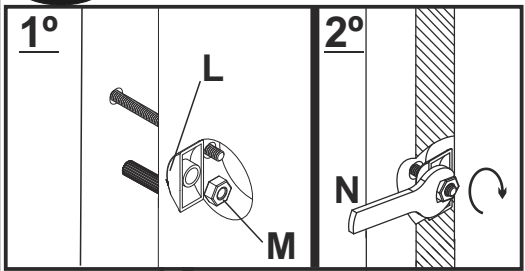

L		Small washer	08
M		Nut 1/4	08
N		Spanner	01

03

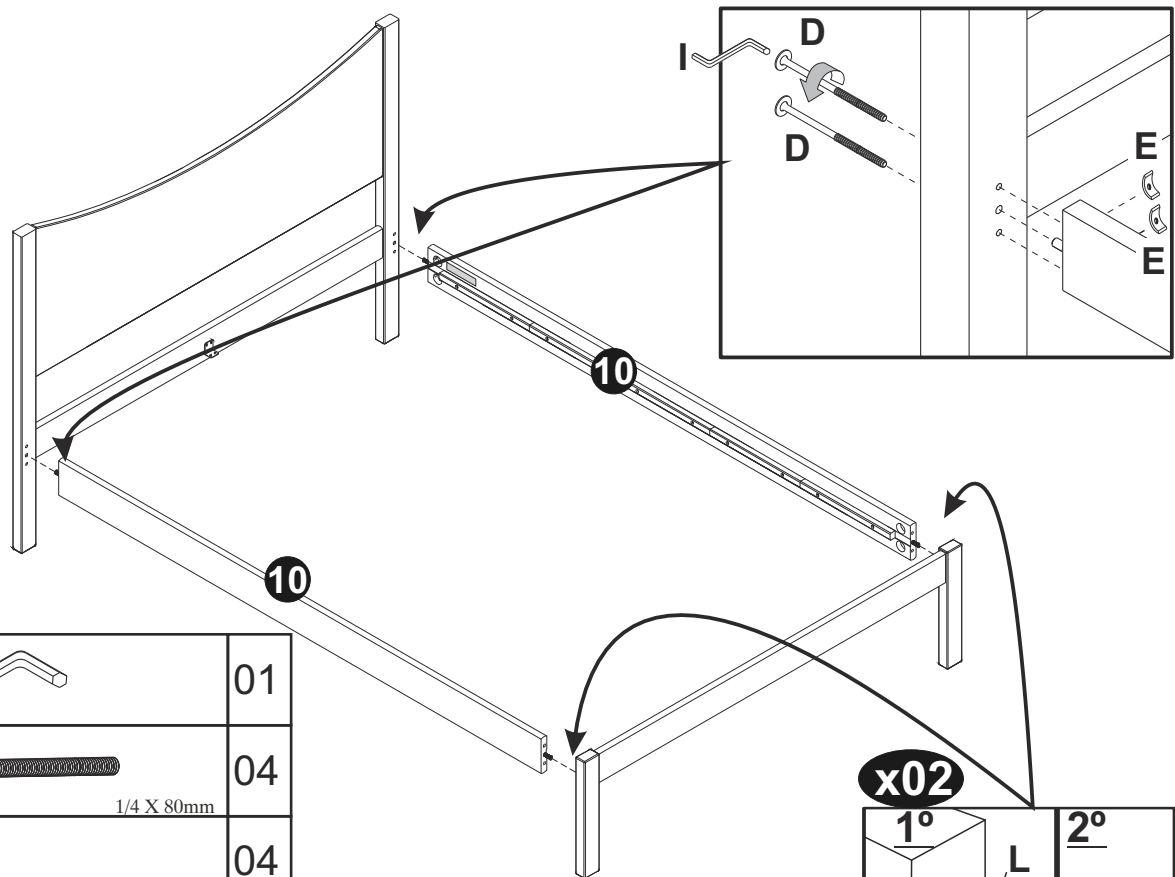

I			01
D		1/4 X 80mm	04
E		Half moon nut 1/4	04
L		Small washer	04
M		Nut 1/4	04
N		Spanner	01

x02

