



**STOP! PLEASE READ FIRST:**

Thank you for purchasing this item from Outdoor Interiors. Please verify all the hardware and components are included as you unpack the carton. Place the items in a safe area to avoid loss and damaging contents. Use a soft area or the empty box to assemble the item.

**ASSEMBLY TIPS:** Assemble on its side while following pictured instructions. Please pre-inserted dowel pin. Never over-tighten any screws or bolts. It 's best to assemble are with 2 people. Never fully tighten any bolt/screw until all inserted on each side. Then tighten.



Please visit our website if you have any question

[www.outdoorinteriors.com](http://www.outdoorinteriors.com)

Please review the "PLEASE OIL ME" card for how to care & maintain your new furniture.

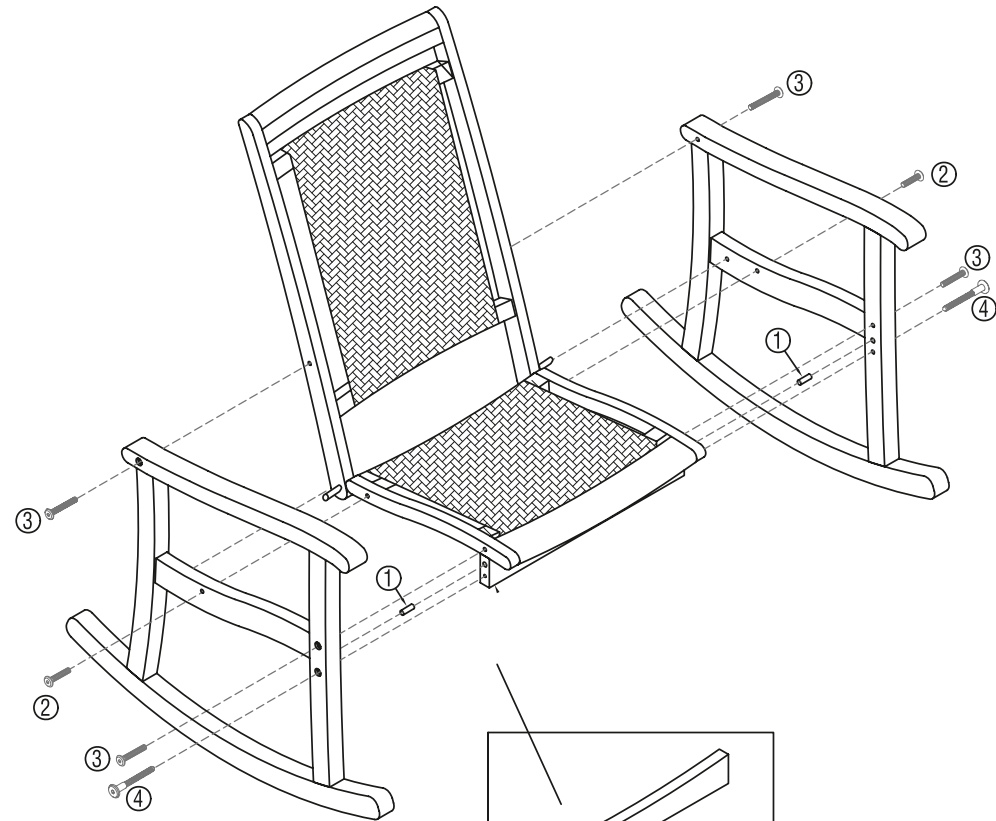
ASSEMBLY INSTRUCTIONS FOR  
21095ASH, 21095RC, 21095RCG & GW21095 -ROCKING CHAIRS

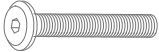
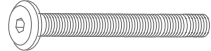
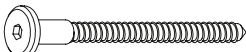

NO.	LIST OF HARDWARE	QTY.
1	WOODEN DOWEL 10*40 	02
2	BOLTS 8*40 	02
3	BOLTS 8*60 	04
4	SCREW 7*90 	02
5	ALLEN KEY A4 	01
6	PORTABLE DRILL BIT 	01

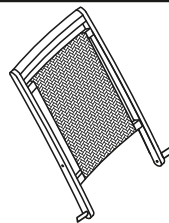

Back (1)

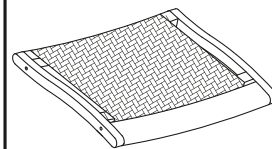

Seat (1)

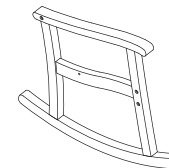

Arm (x2 left & right)

