

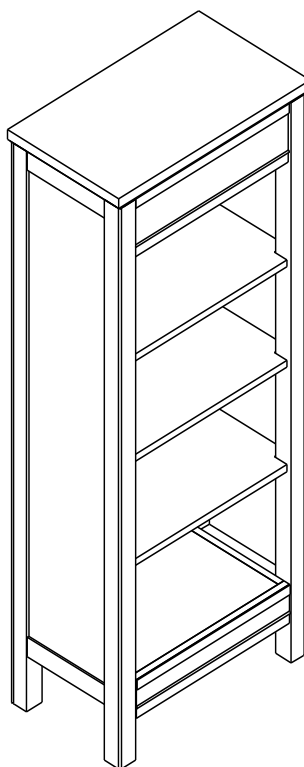











## Painted Farmhouse 4 Shelf Bookcase - OTNS3 & OTNS2



Thank you for purchasing our Tall Bookcase. It is helpful to have a second person available during the assembly of this product.

Lay out parts on a non-abrasive surface to avoid scratching finish.

NO.	DRAWING	DESCRIPTION	QTY.
A		TOP	1
B		SIDE PANEL-L	1
C		SIDE PANEL-R	1
D		BACK	1
E		BOTTOM	1
F		SHELF	3

NO.	DRAWING	DESCRIPTION	QTY.
G		M6*35MM BOLT	8
H		SHELF SUPPORT	12
I		WRENCH	1
J		ANTI-TIP BAG	1

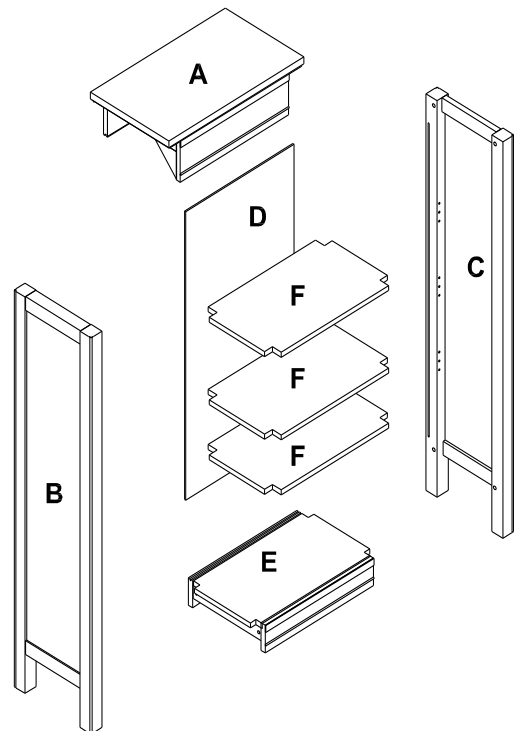

**STEP 1**

Identify and count all parts using diagram above.

**STEP 2**

Identify and count hardware.

**STEP 3**

Position Top Assembly (A) upside down on non-abrasive surface. Attach Left Side Panel (B) using 2 M6 \* 35MM Bolts (G). Use Wrench (I) to install Bolts.

Position Back Panel (D) in to grooves on Left Side Panel (B) and in Back Rail on Top (A).

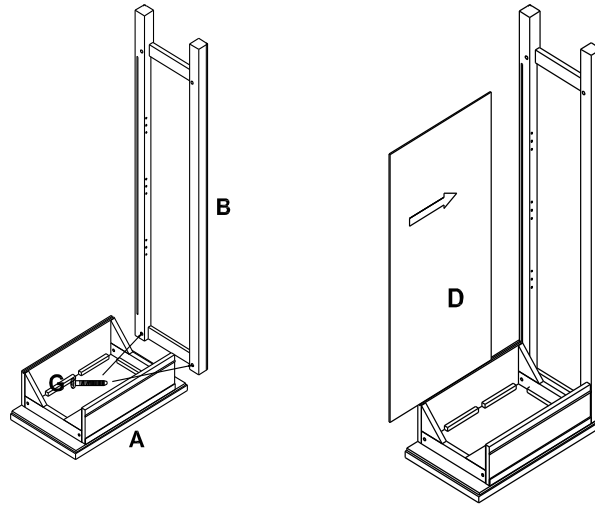

**Do not over tighten Bolts at this time.  
Assemble Loose.**

---

**STEP 4**

Align groove in Right Side Panel (C) with Back Panel. Attach Right Side Panel (C) to top panel (A) using 2 M6 \* 35MM Bolts (G). Use Wrench (I) to install Bolts.

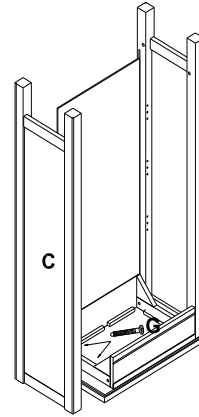

**Do not over tighten Bolts at this time.  
Assemble Loose.**

---

**STEP 5**

Position Bottom Panel (E) between the Left and Right Ends. Align the Groove in the Bottom with the Back Panel. Attach bottom panel (E) to Right and Left End Panels (B) and (C) with 4 M6 \* 35MM Bolts (G). Use Wrench (I) to install and tighten all Bolts.

**At this point tighten all assembly bolts.**

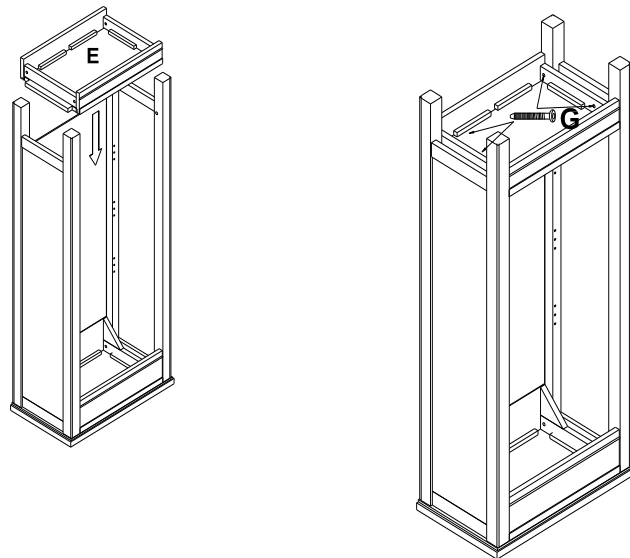

**STEP 6**

Position assembled Bookcase upright. Insert 12 Adjustable Shelf Support (H) in to desired location. Position 3 Adjustable Shelves (F) on to the Adjustable Shelf Supports. Make sure the Adjustable Shelves are Seated Firmly down on the Shelf Supports.

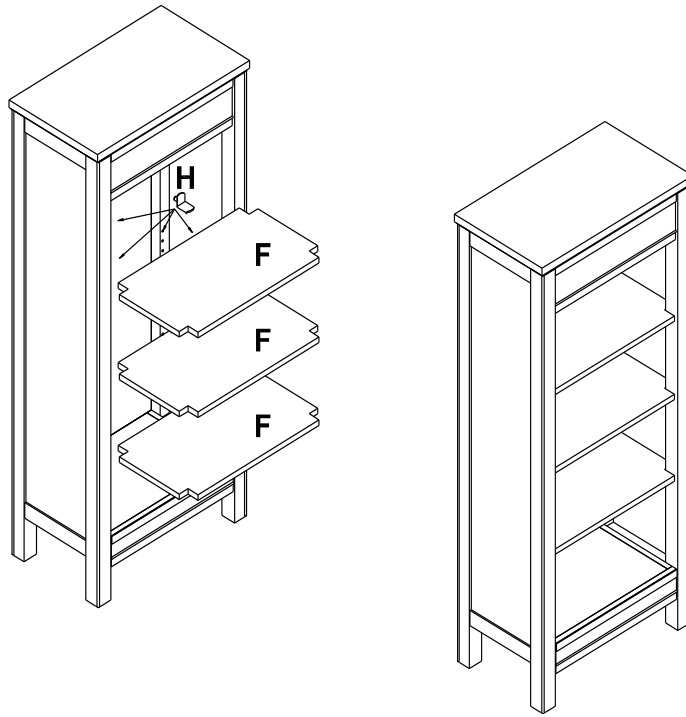

---

CARE: Clean with mild soap and wipe dry.



[www.llbean.com](http://www.llbean.com)

Product Support 1 800 341 4341